

BETE®

EQUIPMENT AND TANK WASHING SOLUTIONS



TW 0618 SI/Metric

EQUIPMENT & TANK WASHING

When choosing a suitable equipment and tank cleaning solution, three different CIP designs are available:

- Stationary Tank Cleaning Nozzles
- Rotating Tank Cleaning nozzles
- Tank Cleaning Machines

Stationary Tank Washing Nozzles

Stationary nozzles, also known as static nozzles, have no moving parts. These specialized BETE products include the innovative HydroClaw[®], and spiral TW. The low-maintenance designs provide sizeable free passage superior to other products on the market. The versatile size range and narrow form of the TW series ensure compatibility with small vessel openings.

Rotating Tank Cleaning Nozzles

Rotating tank wash nozzles, like BETE's slotted HydroWhirl[®] S and PTFE HydroWhirl[®] Poseidon[®] series, use the reaction force of the spray media to drive the rotation of the nozzle head. These provide complete 360° coverage and efficient cleaning through impact and repetition. Rotating nozzles ensure a significant increase in tank washing efficiency over static spray balls, saving time and money by reducing water and cleaning agent consumption while decreasing downtime.

Tank Cleaning Machines

Tank cleaning machines, such as the HydroWhirl[®] Orbitor and Orbitor100 models, use the spray media flowing through internal gears on the body to rotate sets of high impact jet nozzles through an efficient 2-axis orbital pattern, providing complete 360° coverage. The jet pattern nozzles utilized on these assemblies provide significantly more impact and impingement force than other styles of tank washing nozzles, making them ideal for hard to clean residues and larger vessels.

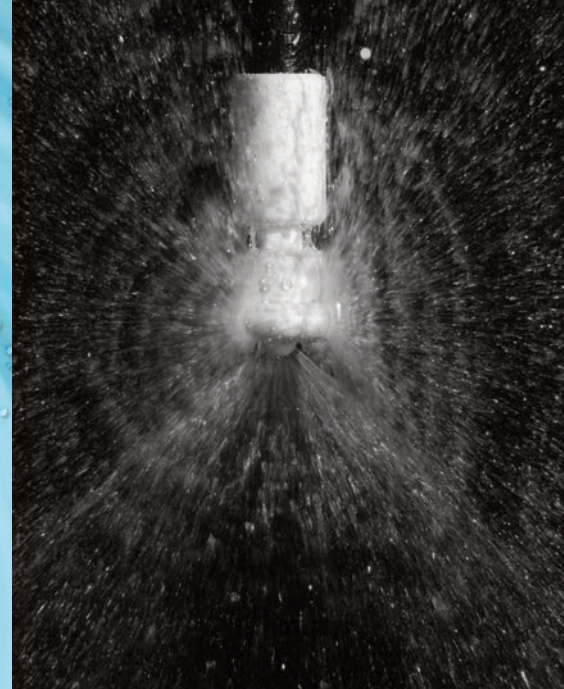

At BETE Fog Nozzle, Inc., our success has always focused on understanding our customers' business. We provide effective engineered solutions for the most challenging fluid process needs.

BETE's mission goes beyond just selling spray nozzles. It is to provide engineered spraying solutions that exceed customer expectations in every detail. Our in-house capabilities include integrated 3D CAD/CAM design, rapid prototyping, investment casting, CNC machining, welded fabrication, and advanced spray testing. We offer the highest level of quality through every phase of production.

The BETE difference is our ability to respond quickly and efficiently to each spraying challenge, with personal customer service every step of the way. Our team draws on over 65 years of experience in the design and manufacturing of spray nozzles and fluid process fabrications. Engineering expertise you can count on from the premier spray nozzle experts.

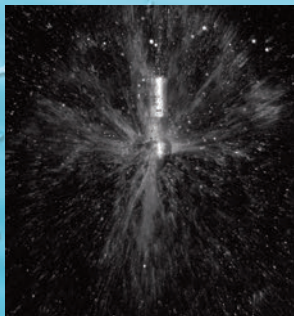

CHOOSING A TANK WASHING NOZZLE

Adequate coverage and effective scrubbing are of prime importance in equipment and tank washing. When selecting BETE nozzles, you should consider the following vessel characteristics and nozzle design criteria: size and shape of the vessel, internals, vessel opening, type of residue to remove, and spray coverage.

Size and Shape of the Vessel to Clean

BETE's tank washing nozzles can be used to clean, wash, and rinse every size vessel from small bottles to a wide variety of process tanks and railroad tankers.

The HydroWhirl® S and TW series offer the best options for cleaning small bottles, kegs, and barrels due to their compact design.

The free passage of the HydroClaw® is an ideal solution for small tanks up to 3m where clogging can lead to downtime. Medium-sized tanks up to 6m are best cleaned using the HydroWhirl® S, or the residue-resistant HydroWhirl® Poseidon® up to 7.6m.

Where higher impact for hard to clean residues or coverage distance for large tanks is needed, BETE's tank washing machines, the HydroWhirl® Orbitor 100 and HydroWhirl® Orbitor, are an excellent choice.

Tank Washing Nozzle	up to	Coverage Distance in Meters (Diameter)												
		2	3	4	5	7	9	12	16	18	20	25+		
HydroClaw	3.0 m													
TW 1	3.6 m													
HydroWhirl S	6.0 m													
HydroWhirl Poseidon	7.6 m													
HydroWhirl Orbitor 100	17 m													
HydroWhirl Orbitor	40 m													up to 40 m



What is ATEX (Ex)?

ATEX is an acronym that stands for 'ATmosphere EXplosible'. BETE products are reviewed and approved under ATEX Directive 2014/34/EU concerning equipment and protective systems intended for use in potentially explosive atmospheres.

All HydroWhirl Orbitor, HydroWhirl Orbitor 100, and HydroWhirl S nozzles are available with ATEX approval.

HydroWhirl® S

Slotted, Rotating Spray Nozzle for Quick, Efficient Tank Cleaning

The HydroWhirl® S nozzle directs the cleaning water through a rotating head at the tip of the spray assembly. This produces a vigorous moving spray action against all areas of the walls of a tank. The spray pattern from the HydroWhirl S head uses impact and repetition to quickly wash the tank. This spray pattern is especially effective at breaking up and removing contaminants.

Advantages of the HydroWhirl® S rotary spray nozzle.

- Cleans more quickly, and uses less water, and lower pressure than static tank washers
- Lower flow and pressure mean smaller pump size resulting in lower operating costs

The HydroWhirl® S nozzle has been carefully designed for long service life.

Low-maintenance bearing design

- Self-cleaning bearings are lubricated by water flow to clear away particles

High-precision machining and finish

- Stainless steel construction – corrosion resistant
- Laser-welded design for durable assembly
- Surface finish of 0.8 µm (microns) R_a or better
- Made from FDA compliant materials for use in Clean-in-Place (CIP) applications

Comprehensive quality control

- Material traceability controlled throughout production
- Quality components carefully designed for long service life
- All HydroWhirl S nozzle are available with ATEX approval for Zone 0

Design flexibility

- Available in many different sizes and connections: threaded, clip-on, or welded
- Spray Angles:
360°, 90° Up, 90° Down, 180° Up, 180° Down, 270° Up, 270° Down
- Flow range: 4.39 – 338 L/min (1.26 – 90.9 gpm)
- Dual bearing design – nozzle operates effectively in any orientation

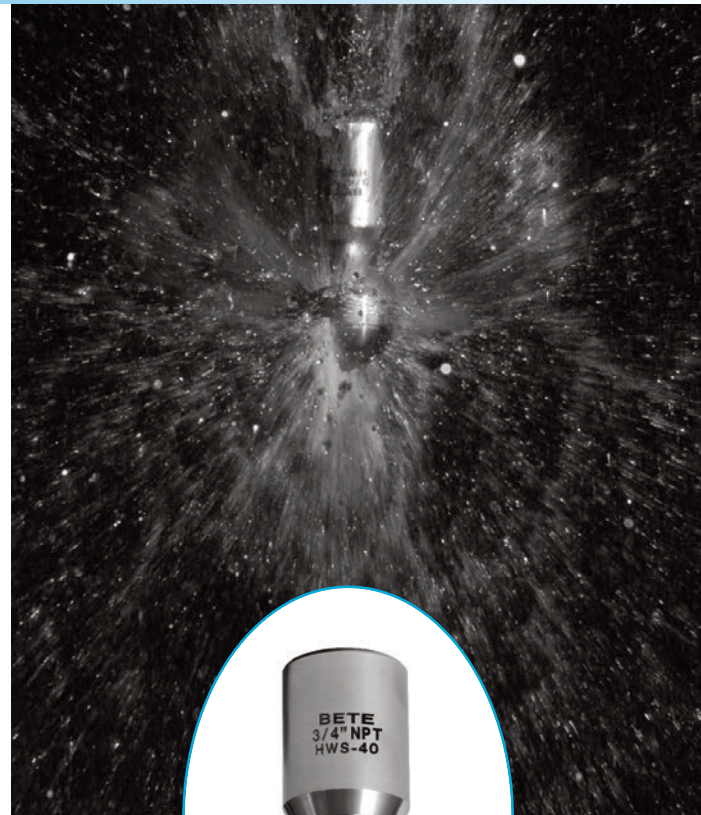

Surface finish ideal for sanitary applications

The HydroWhirl S nozzle is an outstanding combination of design, quality, and engineering. The HydroWhirl S nozzle is ideal for anyone who needs reliable, efficient cleaning of tanks and other interior spaces.

All HydroWhirl S nozzles are available with ATEX approval.



HydroWhirl® S

Tank Washing - Slotted Spray Nozzle

DESIGN FEATURES

- Cleans more quickly, and uses less water and lower pressure than static tank washers
- Surface finish of 0.8 µm (microns) R_a or better: ideal for sanitary applications
- Laser-welded design for durability
- Stainless steel construction – corrosion-resistant material
- Three connections: threaded, clip-on, and welded
- Made from FDA compliant materials for use in Clean-In-Place (CIP) applications

SPRAY CHARACTERISTICS

- Self-cleaning bearings
- Vigorous moving spray action
- Spray Angles: 360°, 90° Down*, 180° Up*, 180° Down, 270° Up, 270° Down, *Not available in all flow rates

Flow rates: 4.39 – 338 L/min

All HydroWhirl S nozzles are available with ATEX approval for Zone 0



STANDARD CONNECTION SIZES													Additional connection sizes available on request			
Connection Type	Nozzle Number															
	HWS-20-3 HWS-20-4 HWS-20			HWS-30-5 HWS-30-6 HWS-30			HWS-40-7.5 HWS-40-8 HWS-40-9 HWS-40			HWS-40HF-11 HWS-40HF			HWS-50-16 HWS-50			
FNPT/G	-	-	1/4"	-	-	1/2"	-	-	1/2"	-	-	1"	-	-	-	
Pipe Clip On	1/8"	-	-	3/8"	-	-	3/4"	-	-	3/4"	-	-	1-1/4"	1-1/2"	-	
Pipe Weld	-	1/4"	1/4"	-	1/2"	1/2"	-	1"	1/2"	-	1"	1"	-	-	2"	
Dim F (mm)	10.3	13.7	13.7	17.1	21.3	21.3	26.7	33.5	21.3	26.7	33.5	33.4	42.2	48.3	60.3	
Tube Clip On	-	-	-	-	-	-	-	-	-	-	-	-	-	-	-	
Tube Weld	3/8"	1/2"	3/8"	1/2"	3/4"	3/4"	1"	-	3/4"	1"	-	1"	1-1/4"	1-1/2"	2"	
Dim F (mm)	9.5	12.7	9.7	12.7	19.1	19.1	25.4	19.1	25.4	25.4	31.8	38.1	50.8	-	-	
DIN Clip On**	DN8	-	-	DN15	-	DN15	DN20	DN25	-	DN15	DN20	DN25	DN40	DN50	-	
DIN Weld**	DN8	DN10	DN10	DN15	DN15	DN20	DN25	DN15	DN20	DN25	DN40	DN50	-	-	-	
Dim F (mm)	10	13	13	19	19	23	29	19	23	29	41	53	-	-	-	

Optimal cleaning performance achieved between 2-3.5 bar; maximum operating pressure is 10 bar.

HydroWhirl S Flow Rates and Dimensions

Nozzle Number	LITERS PER MINUTE @BAR						Dimensions (mm)					Wt. (g)	Coverage Diameter (m) @2.75 bar	
	0.5 bar	0.7 bar	1 bar	2 bar	3 bar	4 bar	A	B (NPT) B (G)	C	D MAX	E			
HWS-20-3	4.39	4.79	5.40	7.05	8.19	9.11	16.7	42.7	69.1	3.81	2.18	24.9	1.5	
HWS-20-4	7.41	8.10	9.20	12.2	14.2	15.9		49.8					1.8	
HWS-20	10.8	12.0	13.9	20.2	25.3	29.1		-					-	
HWS-30-5	7.71	8.80	10.4	15.3	18.9	21.9	27.9	60.3	83.3	5.33	2.18	93.0	2.4	
HWS-30-6	19.5	21.0	23.4	29.8	34.2	37.6		66.5						
HWS-30	19.1	21.7	25.7	37.0	45.4	53.1		-					-	
HWS-40-7.5	18.8	21.3	25.1	35.7	43.8	50.7	38.9	92.7	108	8.89	3.96	306	3.4	
HWS-40-8	21.5	24.3	28.6	40.6	49.6	57.2		100						
HWS-40-9	26.6	30.2	35.7	51.5	63.0	72.7		-						-
HWS-40	30.2	34.6	41.2	59.9	71.8	82.5		-						-
HWS-40HF-11	40.9	46.4	54.5	77.3	95.0	109	38.9	92.7	108	8.89	3.96	302	4.0	
HWS-40HF	50.4	57.3	67.5	97.0	116	132		100						
HWS-50-16	81.6	92.0	108	154	188	218	69.1	158	180	8.89	5.56	1524	5.5	
HWS-50	125	142	167	238	293	338		164						

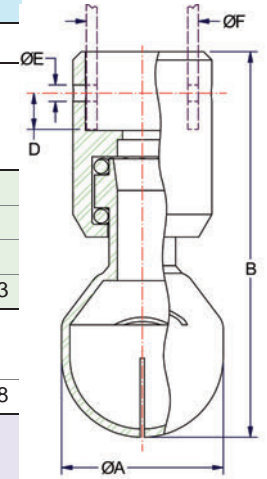

Threaded and Clip On Connections

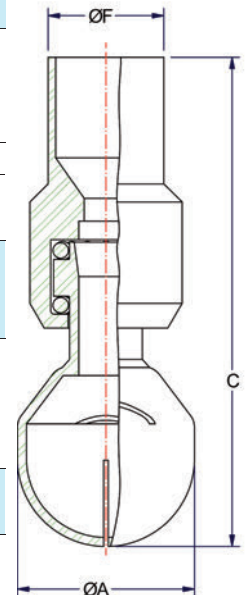

Weld On Connections

Standard Materials: Nozzle: 316L Stainless Steel; Ball Bearings: 316 Stainless Steel

*Flow rates represent threaded connections with a 360° spray angle. Flow rates may vary for other connection types and spray angles, please contact BETE for more information.

**Per DIN 11866 Part A / DIN 11850 Part B

HydroWhirl® Poseidon® Spray Nozzles for Quick, Efficient Tank Cleaning

The HydroWhirl Poseidon tank washing nozzle directs the cleaning water through a rotating head at the tip of the spray assembly. This produces a slow-moving, high-impact spray action against internal surfaces of the tank. The HydroWhirl Poseidon nozzle head uses impact and repetition to quickly break up and wash away contamination. The combination of the spray pattern and slow rotation of the HydroWhirl Poseidon tank washing nozzle is especially effective at removing scum rings or tougher, viscous material.

Advantages of the HydroWhirl® Poseidon® rotary tank washing nozzle

- Cleans more quickly and uses less water and lower pressure than static tank washers
- Complete 360° omnidirectional coverage
- Slow rotation speed provides higher impact and more efficient cleaning
- Durable PTFE nozzle construction withstands extreme chemical and elevated temperature environments
- Simple internal design allows reliable flow-through operation
- Design validated by lab testing to 93 °C (200 °F)
- Maintenance-friendly design allows disassembly, inspection, and reassembly with basic hand tools
- Made from FDA compliant materials for use in Clean-in-Place (CIP) applications

The HydroWhirl® Poseidon® tank-washing nozzle has been carefully designed for long service life

Comprehensive Quality Control:

- Material traceability controlled throughout production
- BETE product quality is maintained using a quality system registered to ISO 9001-2015

Design Flexibility:

- Threaded, pipe, tube, or DIN clip-on connections are available
- Flow range: 58.3 to 333 L/min

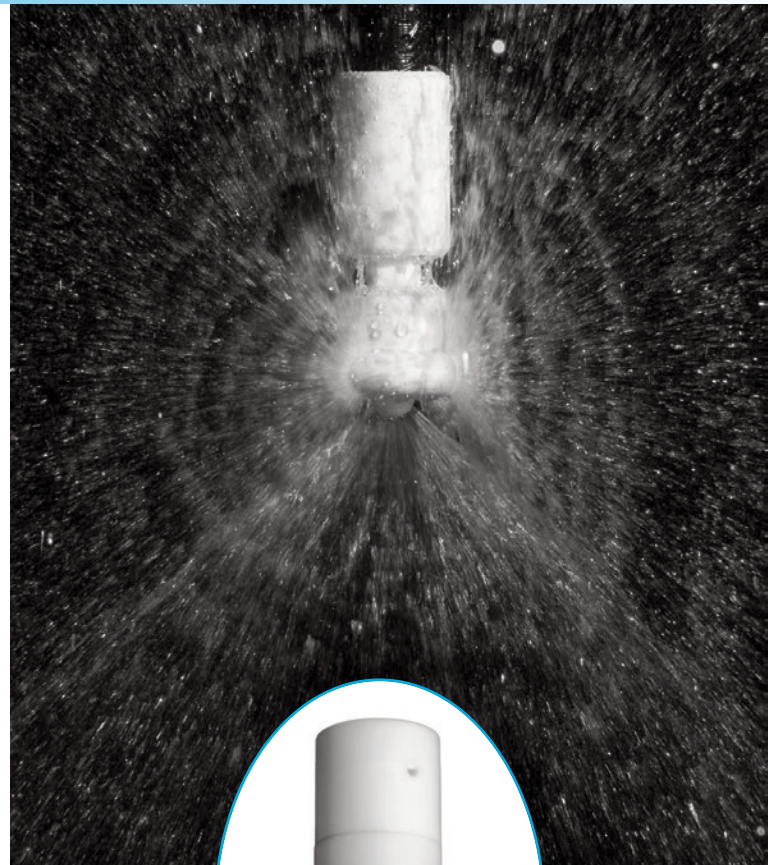

*Corrosion resistant PTFE is ideal
for harsh chemical environments*

The HydroWhirl Poseidon tank washing nozzle is an outstanding combination of design, quality, and performance.

The HydroWhirl Poseidon tank washing nozzle is ideal for anyone who needs a polymer nozzle for reliable, efficient cleaning of tanks and other interior spaces.

HydroWhirl® Poseidon®



Tank Washing - PTFE Spray Nozzle

DESIGN FEATURES

- Cleans more quickly and uses less water and lower pressure than static tank washers
- PTFE construction:
 - Ideal for harsh chemical environments
 - Corrosion resistant
- Available in threaded, pipe, tube, or DIN clip-on connections
- Made from FDA compliant materials for use in Clean-In-Place (CIP) applications.

SPRAY CHARACTERISTICS

- Slow spinning produces longer spray dwell time on the target surface, increasing impact over conventional rotating designs
- Complete 360° omnidirectional spray pattern, other spray angles available upon request

Flow rates: 14.3 to 307 L/min

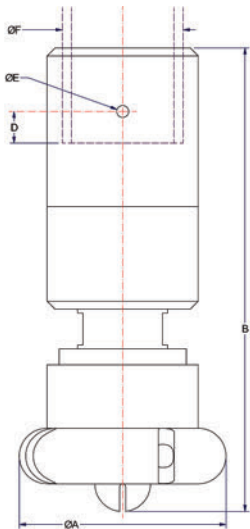

STANDARD CONNECTION SIZES

Connection Type	Nozzle Number											
	HWP-10			HWP-23 HWP-28			HWP-32 HWP-37		HWP-48 HWP-55 HWP-65 HWP-73			
FNPT/BSP	1/4"	3/8"	1/2"	3/8"	1/2"	3/4"	1/2"	3/4"	1"	1"	1-1/4"	1-1/2"
Pipe Clip-On							X					
Dim F (mm)	13.7	17.3	21.3	17.3	21.3	26.7	21.3	26.7	33.5	33.5	42.2	48.3
Tube Clip-On	1/2"	3/4"	3/4"	1"	1"	1-1/4"	1-1/2"	1-3/4"				
Dim F (mm)	12.7	19.1	19.1	25.4	25.4	31.8	38.1	44.5				
DIN Clip On**	DN10	DN15	DN15	DN20	DN20	DN25	DN40					
Dim F (mm)	13	19	19	23	23	29	41					

HydroWhirl Poseidon Nozzle Flow Rates* and Dimensions

Nozzle Number	Spray Angle	LITERS PER MINUTE @BAR						Dimensions (mm)				Mass (g)	Coverage Diameter (m) @2.8 bar
		0.5 bar	1 bar	1.5 bar	2 bar	3 bar	4 bar	A	B	D MAX	E		
HWP-10	360°	14.3	20.3	24.9	28.8	35.4	40.9	42.7	100.1	12.7	2.4	85.0	2.7
HWP-23		30.3	43.1	52.9	61.2	75.2	87.0	49.5	104.6	12.7	4.1	113	3.4
HWP-28		34.6	49.0	60.0	69.3	84.9	98.0						4.3
HWP-32		37.5	53.8	66.5	77.2	95.4	111	76.2	162.6	12.7	4.8	595	4.3
HWP-37		48.5	69.2	85.2	98.7	122	141						4.9
HWP-48		66.0	94.0	116	134	165	191	83.8	185.4	12.7	4.8	822	7.3
HWP-55		75.4	107	132	153	188	218						7.6
HWP-65		98.7	140	171	198	243	281						
HWP-73		108	153	187	216	265	307						

Standard Materials: Nozzle: PTFE; Retaining Clip: 316 stainless steel

*Flow rates represent threaded connections with a 360° spray angle. Flow rates may vary for other connection types and spray angles, please contact BETE for more information.

**Per DIN 11866 Part A / DIN 11850 Part B

www.BETE.com

HydroWhirl® Orbitor Tank Cleaning Machines Ideal for High Impact Cleaning

The HydroWhirl Orbitor and HydroWhirl Orbitor 100 are versatile tank cleaning machines designed to meet the high standards required in the food, brewing, beverage, dairy, and chemical industries combining high performance cleaning efficiency with extended operating life and reduced life cycle costs.

Advantages of the HydroWhirl® Orbitor tank cleaning machines

- The HydroWhirl Orbitor and Orbitor 100 can be stripped, maintained, and rebuilt in less than 15 minutes
- The HydroWhirl Orbitors are self cleaning and self lubricated
- Enhanced external cleaning with dedicated nozzles that clean the external surfaces of the machine and its mounting pipe
- Designed for use where high impact cleaning is required
- The HydroWhirl Orbitors are ideal for use in larger tanks and where the product is difficult to clean
- Designed with minimum moving parts to ensure extended operating life and reduced down time

AVAILABLE VERSIONS

- 2 or 4 nozzle machines
- Variable cycle times
- Male or female connections
- 360° wash pattern
- 180° down wash pattern
- 180° up wash pattern

Typical HydroWhirl® Orbitor Applications

Typically used where high impingement cleaning is required and where the most efficient use of utilities is necessary.

BREWING

Bright beer tanks, coppers, maltings

COATINGS AND PAINTS

Storage silos, process vessels, mixers

FOOD AND DAIRY

Raw milk storage, spray driers, process vessels, storage silos

CHEMICAL

Process vessels, mixers, storage silos

BEVERAGE

Process vessels, storage silos



Key Features and Benefits:

- Designed to meet hygienic standards; external surface finish of 0.5 µm (microns) R_a or better
- Optimum consumption of water, chemicals, and time = reduced operating costs
- Minimum moving parts = reduced lifecycle costs
- Self cleaning; self lubricating = no process contamination
- High impact jets; orbital wash pattern = high efficiency cleaning process
- Compact design = will fit through small access flanges
- 2 or 4 nozzle configuration = wash pattern variable up to super intense



All HydroWhirl Orbitor and HydroWhirl Orbitor 100 tank cleaning machines are available with ATEX approval.

HydroWhirl® Orbitor

High Impact Rotary Tank Cleaning Machine

DESIGN FEATURES

- Easily field-serviced to reduce maintenance costs
- Minimum moving parts to extend operating life
- Self cleaning; self lubricating
- High-impact jets; orbital wash pattern = high efficiency cleaning process
- Compact design
- 2 or 4 nozzle configurations = wash pattern variable up to super intense
- Male or female connections

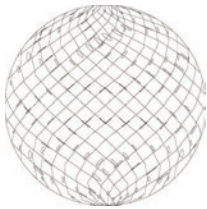

Orbitor 2 nozzle spray pattern

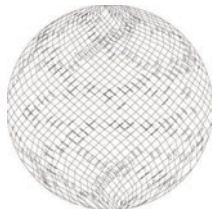

Orbitor 4 nozzle spray pattern

SPRAY CHARACTERISTICS

- 360° wash pattern.
- 180° patterns available on request
- Variable cycle times
- High impact cleaning

Flow rates: 80 - 600 L/min

Working Pressure: 3 - 10 bar

Materials:

Housing and Nozzle Head: 316L

Gears: PEEK + 316 SS

Bushings/Seals: Carbon Filled PTFE

Max. Working Temp.: 95 °C

Max. Ambient Temp.: 140 °C

Weight: 7.5 kg

Minimum opening size is 5" for either 2-nozzle or 4-nozzle standard-capacity model- with jets vertically aligned.



All HydroWhirl Orbitor tank cleaning machines are available with ATEX approval.

Jet lengths are effective cleaning lengths

# Nozzles X Orifice Size	4 x 4.2 mm			4 x 5 mm			4 x 6 mm			4 x 7 mm			4 x 8 mm		
	Flow (L/min)	Jet Length (m)	Cycle Time (min)	Flow (L/min)	Jet Length (m)	Cycle Time (min)	Flow (L/min)	Jet Length (m)	Cycle Time (min)	Flow (L/min)	Jet Length (m)	Cycle Time (min)	Flow (L/min)	Jet Length (m)	Cycle Time (min)
3	80.0	2.9	11	112	4	13	138	5.3	15.5	217	6.5	11.4	250	7.2	15.5
4	100	3	9.3	137	4.2	10.8	170	5.7	12.9	252	7.1	9.8	293	8	12.9
5	115	3.5	7.9	155	4.7	9.4	200	6.2	11	283	7.7	8.7	333	9	11
6	127	4	6.9	173	5.2	8	220	7	9.5	310	8.5	8.1	367	9.9	9.5
7	138	5	6.3	185	6.3	7.3	240	8	8.4	333	9.4	7.5	395	10.6	8.5
8	147	6.2	5.8	195	7.5	6.8	257	9.4	7.6	350	10.3	7.1	418	11.2	7.8
9	153	7.1	5.6	202	8.5	6.5	270	10.3	7	367	11.2	6.9	438	12.2	7
10	157	7.8	5.5	207	9	6.4	282	11.2	6.9	380	12	6.6	458	13	6.9
# Nozzles X Orifice Size	2 x 6 mm			2 x 7 mm			2 x 8 mm			*2 x 10 mm			*2 x 12.5 mm		
	Flow (L/min)	Jet Length (m)	Cycle Time (min)	Flow (L/min)	Jet Length (m)	Cycle Time (min)	Flow (L/min)	Jet Length (m)	Cycle Time (min)	Flow (L/min)	Jet Length (m)	Cycle Time (min)	Flow (L/min)	Jet Length (m)	Cycle Time (min)
3	80.0	5.5	33	93.3	6.5	37.5	117	7.2	25.7	217	9.8	41	330	10.1	26.8
4	91.7	6	27.2	117	7.2	31.6	150	8	22.9	255	10.5	34.2	383	11.2	24
5	108	6.3	24.7	137	7.9	28.2	172	8.7	20.5	290	11.5	30.5	433	12.1	21.7
6	122	7	22.6	153	8.5	25.8	190	9.4	18.9	320	12.7	28	473	13.4	19.8
7	130	8	21	168	9.2	24	203	10.3	17.5	347	13.9	26	512	14.8	18.4
8	140	9	19.5	182	10.4	22.3	213	11.3	16.4	368	15.2	24.5	547	16.4	17.2
9	148	10.2	18.4	192	11.3	21	223	12.4	15.6	390	17	23.2	572	18.3	16.3
10	157	11.5	17.4	200	12.3	20	232	13.5	14.9	405	18.8	22	600	20.1	15.5

HydroWhirl® Orbitor 100

High Impact Rotary Tank Cleaning Machine

DESIGN FEATURES

- Easily field-serviced to reduce maintenance costs
- Minimum moving parts to extend operating life
- Self cleaning; self lubricating
- High-impact jets; orbital wash pattern = high efficiency cleaning process
- Ideal for small to medium tanks, easily fits through Ø100 mm (4") openings
- 4 nozzle configurations
- Female connections

SPRAY CHARACTERISTICS

- 360° wash pattern
 - Variable cycle times
 - High impact cleaning
- Flow rates:** 44.8 - 198 L/min
Working Pressure: 3 - 10 bar

Materials:

Housing and Nozzle Head: 316L
 Gears: PEEK + 316 SS
 Bushings/Seals: Carbon Filled PTFE

Max. Working Temp.: 95 °C (200 °F)

Max. Ambient Temp.: 140 °C (285 °F)

Weight: 2.5 kg



Orbitor 100

HydroWhirl Orbitor

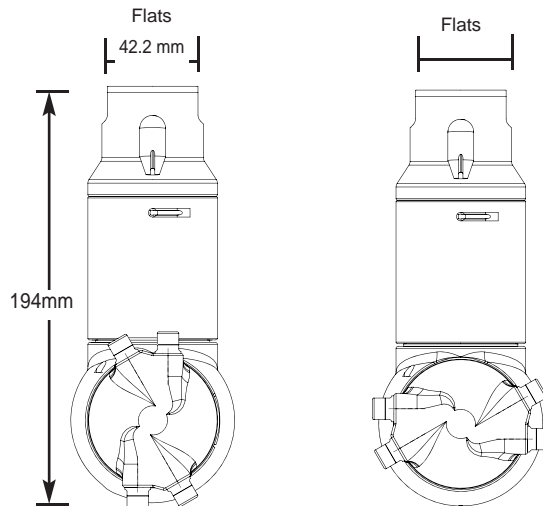

Vertical Nozzle Head Alignment
 Clearance Diameter: 85 mm

Horizontal Nozzle Head Alignment
 Clearance Diameter: 100 mm



All HydroWhirl Orbitor 100 tank cleaning machines are available with ATEX approval

Performance may vary with ATEX models.

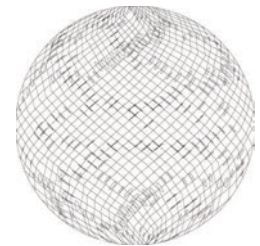

4 nozzle spray pattern

Jet lengths are effective cleaning lengths

# Nozzles X Orifice Size	4 x 3 mm			4 x 4 mm			4 x 5 mm			4 x 6 mm		
	Flow (L/min)	Jet Length (m)	Cycle Time (min)	Flow (L/min)	Jet Length (m)	Cycle Time (min)	Flow (L/min)	Jet Length (m)	Cycle Time (min)	Flow (L/min)	Jet Length (m)	Cycle Time (min)
3	44.8	3.7	6.1	66.5	4.3	5.5	88.5	4.9	4.5	115	5.4	4.0
4	51.7	4.5	5.5	75.6	5.1	4.8	99.5	5.7	4.0	127	6.2	3.5
5	58.5	5.1	4.9	84.5	5.8	4.2	110	6.4	3.5	139	6.9	3.1
6	65.2	5.6	4.4	93.2	6.4	3.7	120	7.0	3.1	151	7.4	2.7
7	71.7	6.1	4.0	102	6.8	3.3	130	7.4	2.7	163	7.9	2.4
8	78.1	6.4	3.6	110	7.2	2.9	139	7.8	2.4	175	8.2	2.1
9	84.4	6.7	3.2	118	7.5	2.7	148	8.0	2.2	187	8.5	1.9
10	90.5	6.9	2.9	127	7.6	2.5	157	8.1	2.0	198	8.6	1.7

TW

Tank Washing

DESIGN FEATURES

- Clog-resistant spiral design
- Energy efficient
- Compact design; fits small openings

SPRAY CHARACTERISTICS

- Easy to maintain
- Unique patterns that spray in opposing directions

Flow rates: 11.4 to 260 L/min

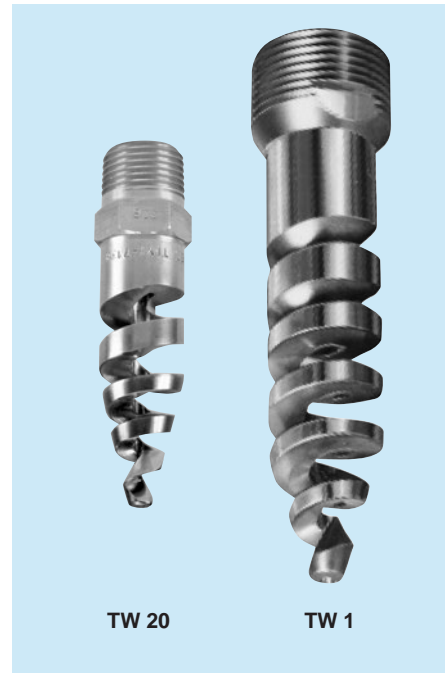

TW 20

TW 1

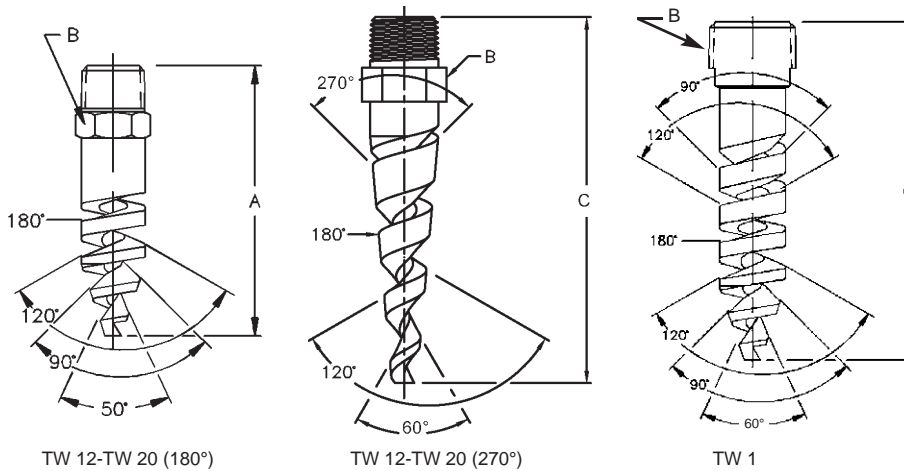

TW 12-TW 20 (180°)

TW 12-TW 20 (270°)

TW 1

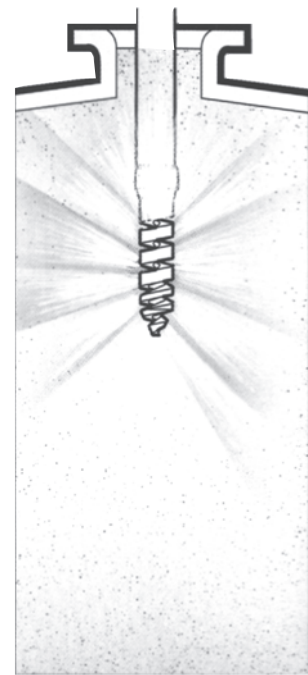

Dimensions are approximate. Check with BETE for critical dimension applications.

Tank Washing TW Coverage Chart

When spraying at 2 - 3 bar

Pipe Size	Nozzle Number	Scrubbing Diameter (mm)	Rinsing Diameter (mm)
3/8	TW12	380	760
	TW14	460	1200
	TW16	610	1500
	TW20	910	2100
1/2	TW24	1200	2700

Dimensions are approximate. Check with BETE for critical dimension applications.

Tank Washing TW Flow Rates and Dimensions

TW 180° and 270°, 3/8", 1/2", and 1" Pipe Sizes

Male Pipe Size	Nozzle Number	Available Spray Angles	K Factor	LITERS PER MINUTE						Approx. (mm)		Metal Only Dim. (mm)			Weight (g) Metal
				0.7 bar	1 bar	2 bar	3 bar	4 bar	5 bar	Orifice Dia	Free Pass. Dia.	A	B	C	
3/8	TW12	180°, 270°	13.7	11.4	13.7	19.3	23.7	27.3	30.6	4.83	3.30	73.0	17.5	92.1	49.6
	TW14	180°, 270°	18.5	15.4	18.5	26.1	32.0	36.9	41.3	5.59	3.30				
	TW16	180°, 270°	24.2	20.2	24.2	34.2	41.8	48.3	54.0	6.35	3.30				
	TW20	180°, 270°	37.6	31.5	37.6	53.2	65.1	75.2	84.1	7.87	3.30				
1/2	TW24	270°	54.9	46.0	54.9	77.7	95.1	110	123	10.4	4.32		22.2	108.0	181
1	TW1	270°	116	97.2	116	164	201	232	260	14.2	5.08		28.7	146.1	298

$$\text{Flow Rate (l/min)} = K \sqrt{\text{bar}}$$

Standard Materials: Brass, 316 Stainless Steel

HydroClaw[®]

Superior Clog-Resistant Nozzle for Ferocious Tank Cleaning

- Triple the free passage of spray balls
- Unique, patent-pending, clog-resistant design with no moving parts
- Complete 360° coverage
- Vigorous rinsing action quickly flushes solids and contamination from vessels

Who needs the HydroClaw[®]?

- Wineries: spray balls get clogged with stems, skins, and seeds
- Breweries: spray balls get clogged with grains and hops
- Juice Processing Plants: tank washing nozzles get clogged with fruit seeds and pulp
- Sugar Processing Plants: rotary nozzles jam up with sticky residue
- Tomato Processing Plants: tank washing nozzles get clogged with seeds and skins

Advantages of the HydroClaw[®]

Low-maintenance design

- Self-draining and self-flushing design
- No moving parts = low maintenance

High-precision machining

- 316L stainless steel construction for food-grade and sanitary applications
- Laser-welded for durability

Designed with your tank in mind

- Available in a variety of connection sizes and types, including threaded, clip-on and welded.
- Fits through compact openings: either 63.5 mm or 76.0 mm diameter
- Spray Angle: complete 360° coverage for tanks up to 3 m diameter
- Free Passage: allows passage of particles 6.4 mm in diameter; three times the free passage of a comparable spray ball
- **Recommended operating pressure:** 2 bar
- Low pressure, high flow for quick, energy-efficient rinse

Visit BETE.com for comprehensive spray nozzle tools, case studies and literature.



Wine Fermentation Tank Cleaned with the HydroClaw



BETE[®]

PERFORMANCE THROUGH ENGINEERING

BETE Fog Nozzle, Inc.

50 Greenfield St.

Greenfield, MA 01301

T (413) 772-0846

www.bete.com

HydroClaw®

Tank Washing - Superior Clog Resistance

DESIGN FEATURES

- Patent-pending, clog-resistant design with no moving parts
- Allows passage of particles 6.4 mm in diameter, three times the free passage of a comparable spray ball
- Made from FDA compliant 316L stainless steel for use in food-grade and sanitary Clean-In-Place (CIP) applications
- Low pressure/high flow operation quickly cleans tank walls to reduce overall water consumption compared to a static spray ball
- Self-draining and self-flushing
- Laser-welded for durability
- Available in a variety of connection sizes and types, including threaded, clip-on and welded.
- Clip-on nozzles include low-profile retaining pin for secure connection
- Fits through compact openings: either 63.5 mm or 76 mm diameter

SPRAY CHARACTERISTICS

- Vigorous rinsing action quickly flushes solids and contamination from vessels
- Complete 360° omnidirectional coverage
- Optimum cleaning performance at 2 bar
- Recommended installation 0.6 - 1.0 m vertically below top of tank

Flow rates: 119 - 442 L/min

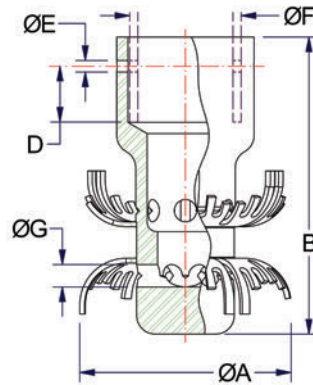

HydroClaw Flow Rates and Dimensions

Connection Types	Nozzle Number	LITERS PER MINUTE @BAR				Dimensions (mm)						Wt (g)	Coverage Diameter (m) @2 BAR
		1.5 BAR	2 BAR	2.5 BAR	3 BAR	A	B	D	E	F	Free Pass. G		
3/4" NPT	HC-42	119	136	152	166	60.5	91.2	-	-	-	6.4	416	2.4
G3/4												413	
1" Tube Weld-On												325	
1-1/2" Tube Clip-On	HC-42	125	145	161	176	60.5	102	19.1	4.1	38.1	6.4	504	2.4
1" Tube Clip-On										25.4		391	
DN20 Tube Clip-On*										23.1		416	
3/4" Pipe Clip-On										26.7		382	
1" NPT	HC-100	279	322	360	394	73.2	102	-	-	-	7.6	649	3.0
G1												635	
1-1/2" Tube Weld-On												425	
1-1/2" Tube Clip-On	HC-100	312	361	403	442	73.2	102	19.1	4.1	38.1	7.6	527	3.0
DN40 Tube Clip-On*										40.0		437	
1" Pipe Clip-On										33.5		598	

Standard Material: 316L Stainless Steel

Clip-on flow rates may vary depending on actual O.D. of installation tube or pipe

*Per DIN 11866 Part A / DIN 11850 Part B

www.BETE.com



Case Study

SOLVING CLOGGING FROM
SEEDS & SKINS

TOMATO PROCESSING TANK WASHING SOLUTION

Seeds, skins, pulp, stems, and grains in a recirculated water system can cause blockage in many tank washing nozzle designs, inhibiting their ability to work correctly. Cleaning tanks and maintaining a sanitary environment is essential to success in food processing and beverage industries. Problems within these systems lead to loss of time, money, and resources – an unacceptable situation.

► **PROBLEM: CLOGGING WITH RECIRCULATED WATER**

A tomato processing plant system designer contacted BETE to help troubleshoot issues with their tank washing system. After installing six total competitor disc cleaning nozzles into two tanks, 100" diameter by 80" high, they observed clogging caused by seeds and skins that were in their recirculated water system. Displeased with constant blockage and too much time wasted on nozzle maintenance, they worked with BETE Applications Engineers to solve the problem and improve efficiencies in keeping their tomato processing tanks clean.

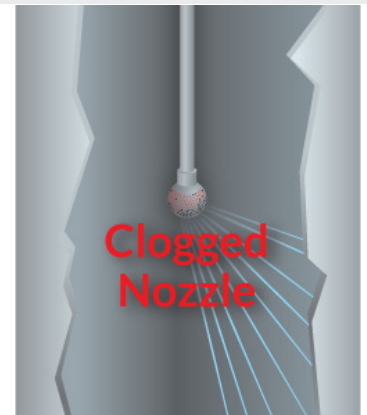

► **SOLUTION: THE BETE HYDROCLAW[®]**

The systems designer had done their research and wanted more information as to whether the innovative HydroClaw was the right solution for their tank washing requirements. After assessing the dimensions of their vessels, BETE engineers recommended six HydroClaw 100 nozzles, three for each tank. The ¼" free passage makes them an ideal solution for flushing through tomato seeds and skins with the recirculated water. The low-maintenance HydroClaw self-flushes as it cleans tanks without any rotating parts or gears to jam up.





WHY CHOOSE BETE FOR YOUR FOOD INDUSTRY NOZZLE NEEDS?

- The ability to solve unique and complex process challenges
- ISO 9001:2015 Certified
- Custom nozzle design and manufacturing with consistent quality assurance

With BETE you get our world-class customer support from a nozzle industry pioneer who has been creatively solving problems for over 65 years.

BETE[®]
PERFORMANCE THROUGH ENGINEERING

50 Greenfield Street,
Greenfield, MA 01301 USA

800-235-0049
413-772-0846

www.BETE.com
sales@BETE.com



Results

After testing the six new HydroClaw 100s in their tank washing system, the tomato processing plant circled back to BETE to express their enthusiasm. Pleased with the performance of the HydroClaw, they requested a quote for twenty three more nozzles to improve tank washing efficiencies at their other locations.

CHALLENGES WITH OTHER TANK WASHING NOZZLES

- Small holes and moving parts lead to clogging
- Nozzle blockage leads to unclean tanks, and more maintenance downtime becomes costly
- The expense of high water consumption from extra wash cycles and the inability to use recycled water effectively

The HydroClaw was explicitly designed to offer a tank washing innovation for wineries – allowing grape seeds and skins to pass through the nozzle. This design feature makes it the perfect nozzle for food processing applications.

Whether used in a tomato processing factory or any other food processing plant, the HydroClaw saves time and money with tanks glistening and ready for the next cycle.

ADVANTAGES OF THE BETE HYDROCLAW[®]

- Nozzle designed to let particulates and sediment flow through with no clogging
- Clog resistance and low maintenance = reduced downtime and more economical water usage
- 316L stainless steel construction means it is perfect for clean-in-place (CIP) and food grade applications
- Complete 360-degree coverage



BETE[®]

BETE Fog Nozzle, Inc.

50 Greenfield St.
Greenfield, MA 01301
T (413) 772-0846
F (413) 772-6729

www.BETE.com

©2018 BETE Fog Nozzle, Inc. All rights reserved.

TW 0618 SI/Metric